

MGS

SOFFIONE SHOWER HEAD

MGS

SCHEMA IDRAULICO  
PLUMBING CONNECTION

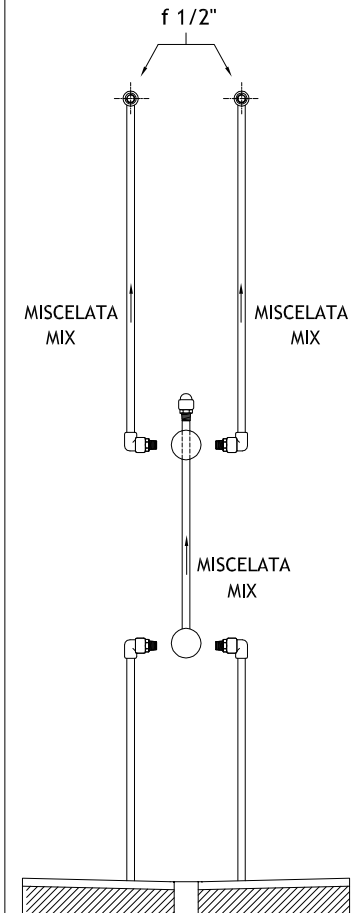

INDICAZIONI PER IL  
RIVESTIMENTO  
DETAILS FOR WALL  
COVERING

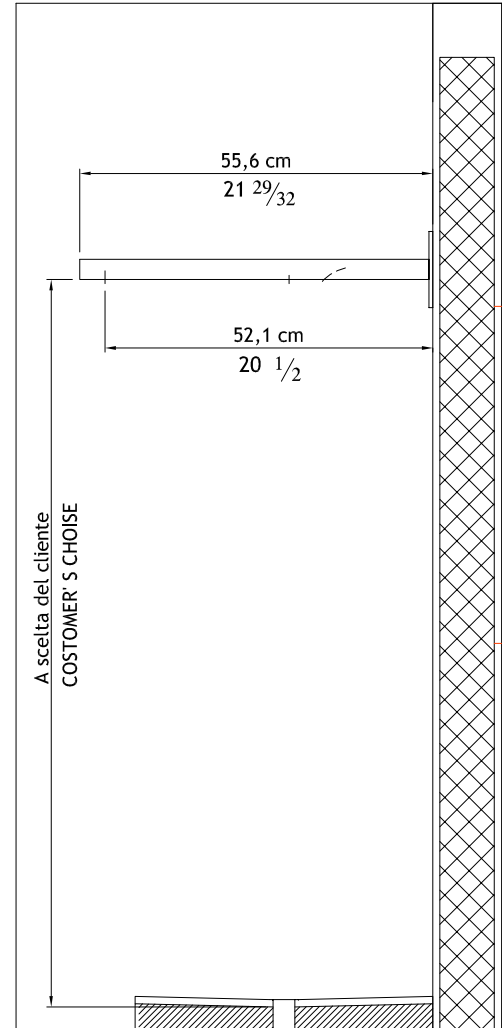
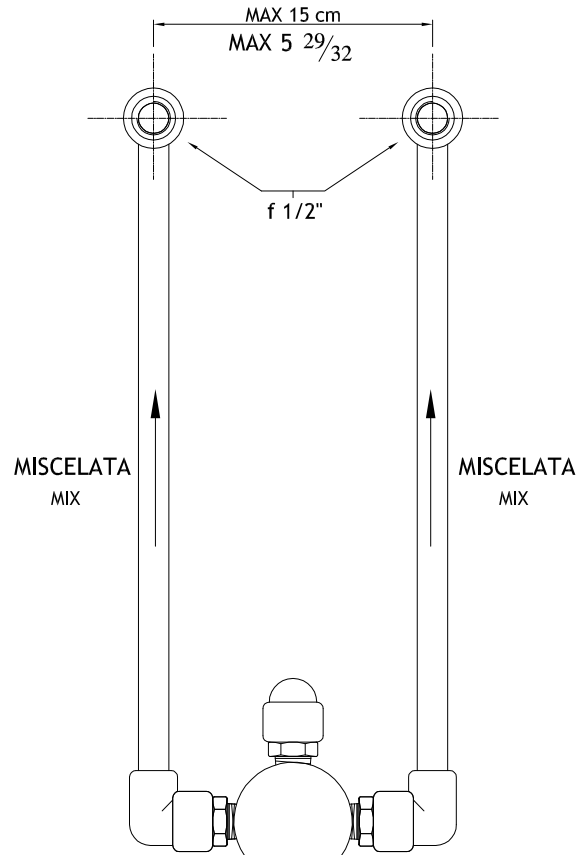

VISTA FRONTALE  
FRONT VIEW

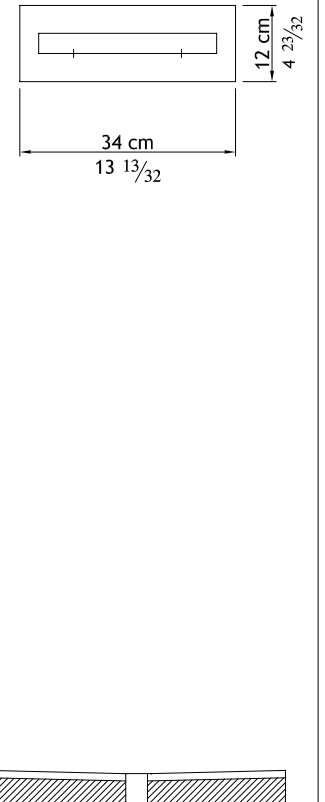

ATTENZIONE

**VERIFICARE CHE L' IMPIANTO SIA PREDISPOSTO A MURO CORRETTAMENTE  
COME INDICATO DALLE FIGURE.**

WARNING

**CHECK THAT PLUMBING CONNECTIONS ON THE WALL ARE AS PER DRAWINGS ABOVE**

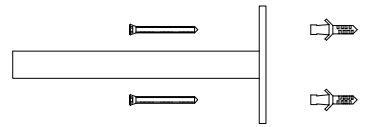
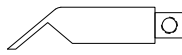
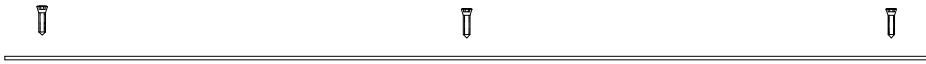

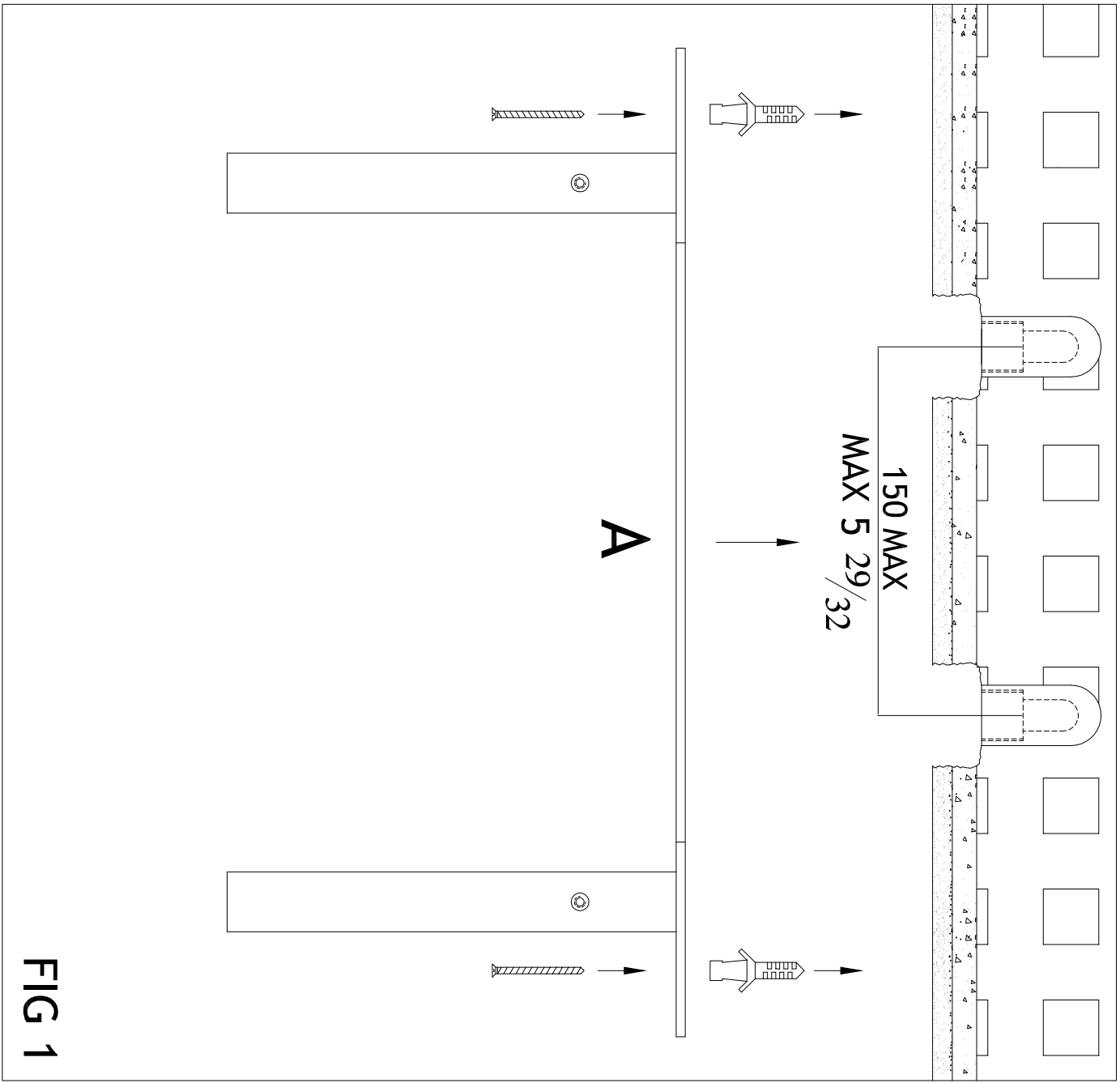
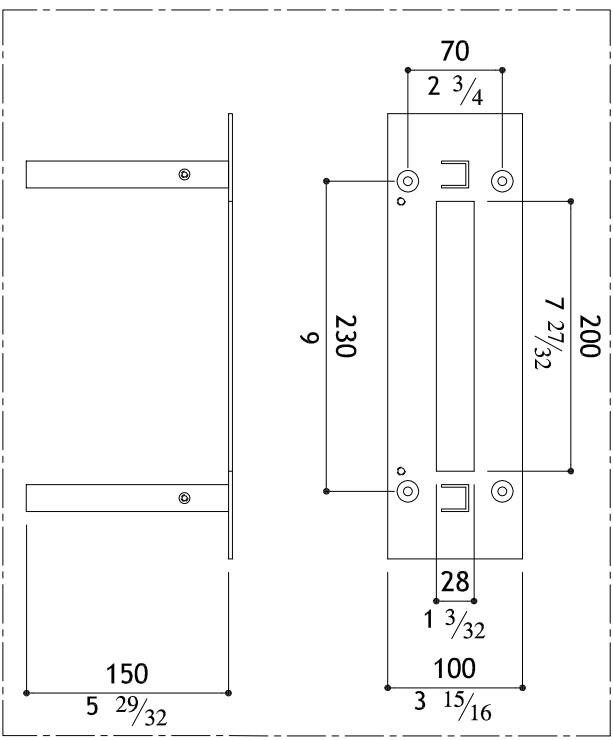
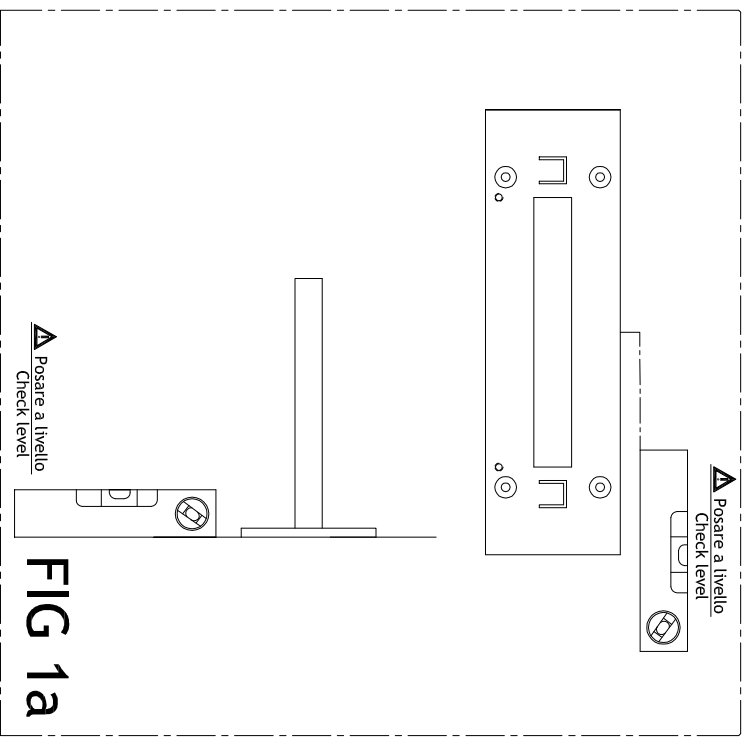
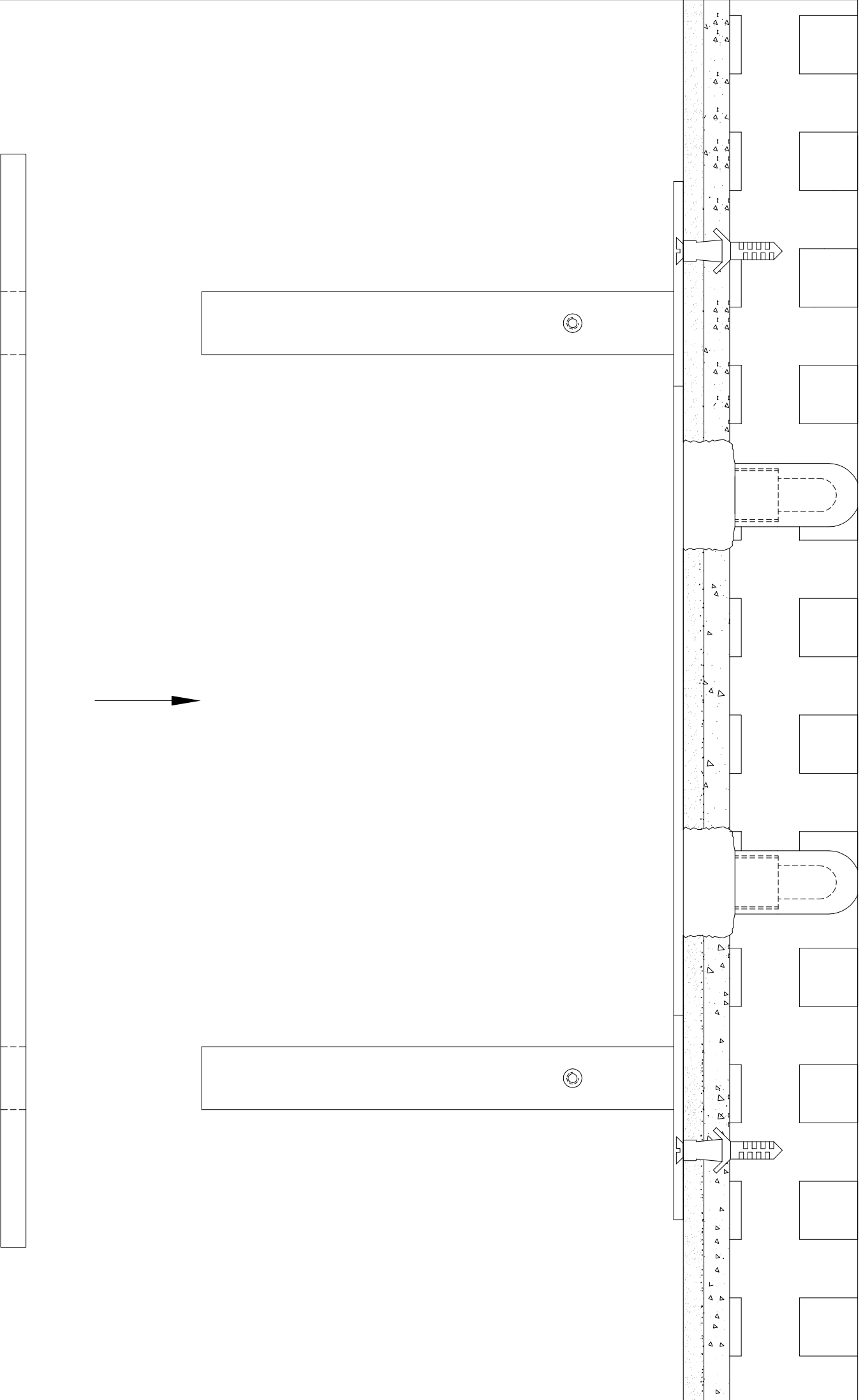

FIG 1





**B**

**FIG 2**

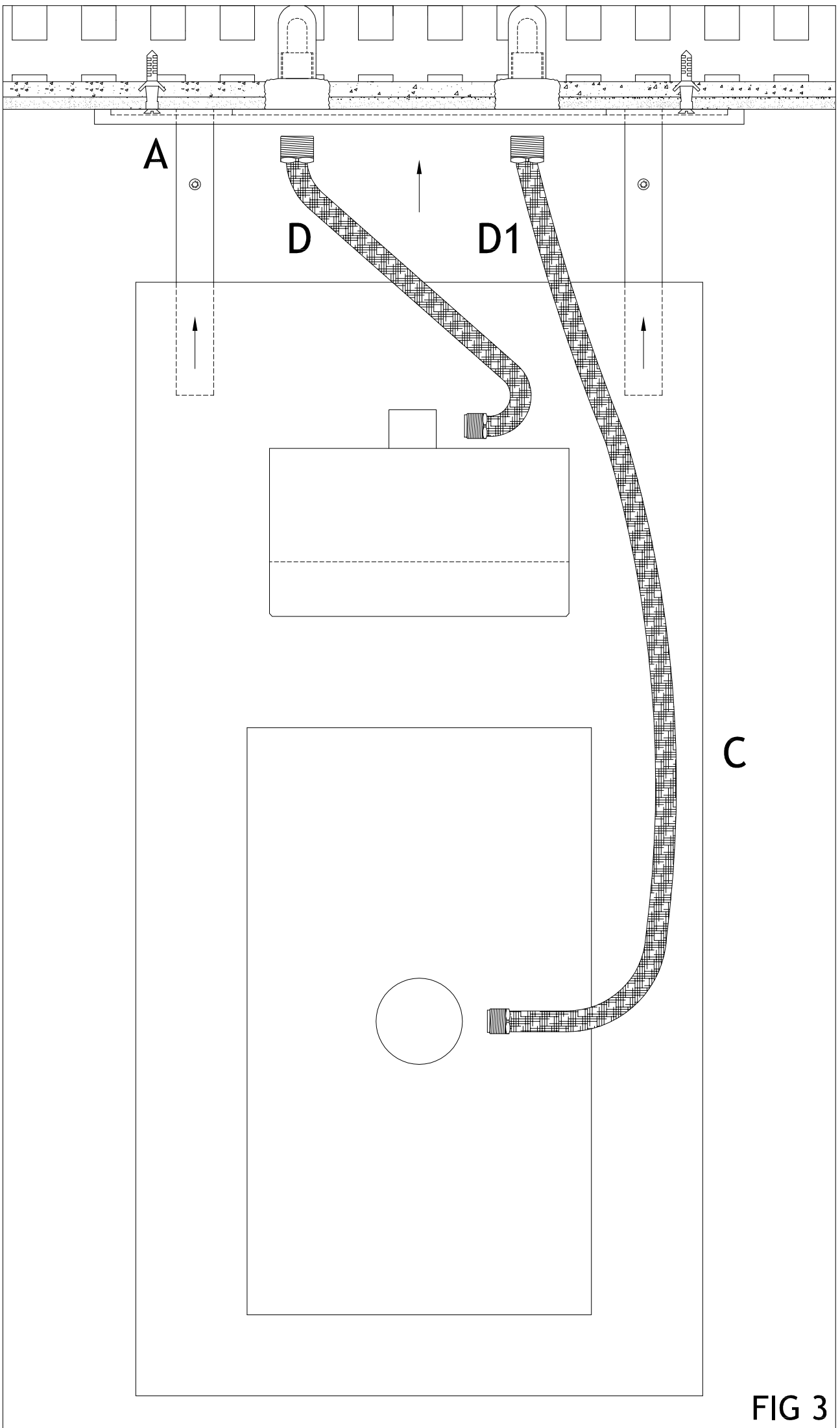
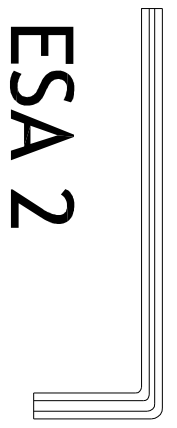
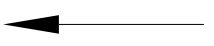

FIG 3



E



C

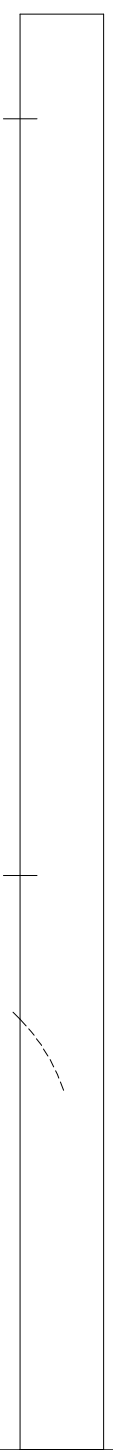

FIG 4

